

F 110

52X66/52x80 M40 motore - motor

SERIE F - F SERIES

CE

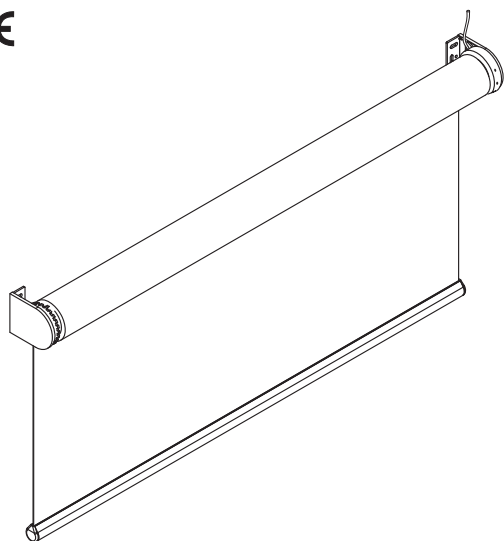

dimensioni in mm  
dimensions shown in mm

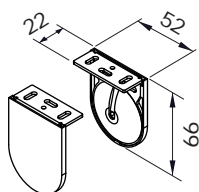

52x66

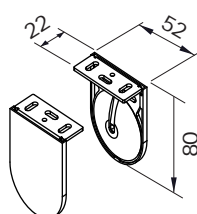

52x80

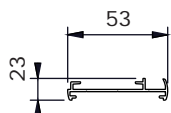

profilo di premontaggio  
aluminum frame

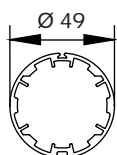

ruolo - tube  
Ø 49

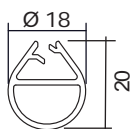

F21 Serie 2012

## varianti - optional

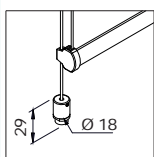

fondale FR23 e cavo perlon  
Ø3mm o acciaio inox Ø2,5mm  
con tenditore per fissaggio piano  
orizzontale, con staffe in acciaio  
per piano verticale

FR23 hem bar and Ø3mm perlon  
or Ø2.5mm stainless steel cable  
with cable tensioning block for  
window sill/floor mounting or  
brackets for wall mounting

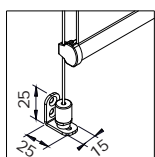

copri staffe magnetici in  
alluminio satinato  
satin finish aluminium  
magnetic bracket covers

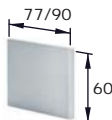

## CARATTERISTICHE:

**Tipo di applicazione:** verticale

**Ambiente di applicazione:** interno. Larghezza minima 80cm

**Staffe di fissaggio:** 52x66 mm in ferro verniciato con copri staffe in PVC (bianco, nero, grigio); staffa 52x80 mm su richiesta. A supplemento copri staffe magnetici in alluminio satinato.

**Rullo di avvolgimento:** Ø 49 mm in alluminio estruso con ogiva per facilitare la manutenzione del telo

**Fondale:** F21 Serie 2012 in alluminio estruso con tappi in PVC. Fondale FR23 con la variante guida cavo perlon.

**Manovra:** a motore tubolare 230V/50Hz, M40, con finecorsa salita/discisa e cavo di alimentazione

Protezione termica e indice di protezione agli spruzzi d'acqua IP44. interruttore escluso.

Calotta lato opposto con perno rientrante per facilitare lo smontaggio del rullo dalle staffe

**Fissaggio:** a parete o a soffitto. A supplemento profilo di premontaggio in alluminio estruso verniciato (bianco Ral 9010, nero Ral 9005 opaco - argento anodizzato)

## CHARACTERISTICS:

**Application:** vertical

**Installation:** indoors. Minimum width 80 cm

**Brackets:** 52x66 mm steel powder coated brackets with PVC covers (white, grey, black), 52x80 mm on request.

Supplement for satin finish aluminium magnetic bracket covers.

**Roller tube:** Ø 49 mm extruded aluminum tube with slot to facilitate fabric removal

**Hem bar:** F21 Serie 2012 extruded aluminum hem bar with PVC caps. FR23 hem bar supplied with guided blind with cable.

**Operation:** M40 230V/50Hz tubular motor with top/bottom limit switches and mains cable, thermal cut-out and class IP44 water resistance. Switch excluded. End plug with retractable pin to easily remove the tube from the brackets

**Mounting:** wall or ceiling. Supplement for powder coated premounting frame (white Ral 9010 - matt black Ral 9005 - silver anodised)

## note - notes

fondale in alluminio estruso FR23 in abbinamento alla variante con cavi - guided blind with cables supplied with FR23 extruded aluminium hem bar

motore M40 - M40 motor

la tenda motorizzata viene fornita senza interruttore blind supplied without switch

## colori standard - standard colours

bianco Ral 9010 - white Ral 9010

avorio Ral 1013 - ivory Ral 1013

marrone Ral 8017 - brown Ral 8017

nero Ral 9005 opaco - matt black Ral 9005

argento anodizzato - silver anodised

## tessuti abbinabili - suitable fabrics

per l'utilizzo dei tessuti consultare la sezione dei teli confezionati e/o Tabella "A"  
for fabric choice consult the fabric section and Tab. "A"

## supplementi - supplement

